

37-7.3G-BL2

Deck Mounted Single Hole Gooseneck Kitchen Faucet
Flow Rate: 1.75 GPM

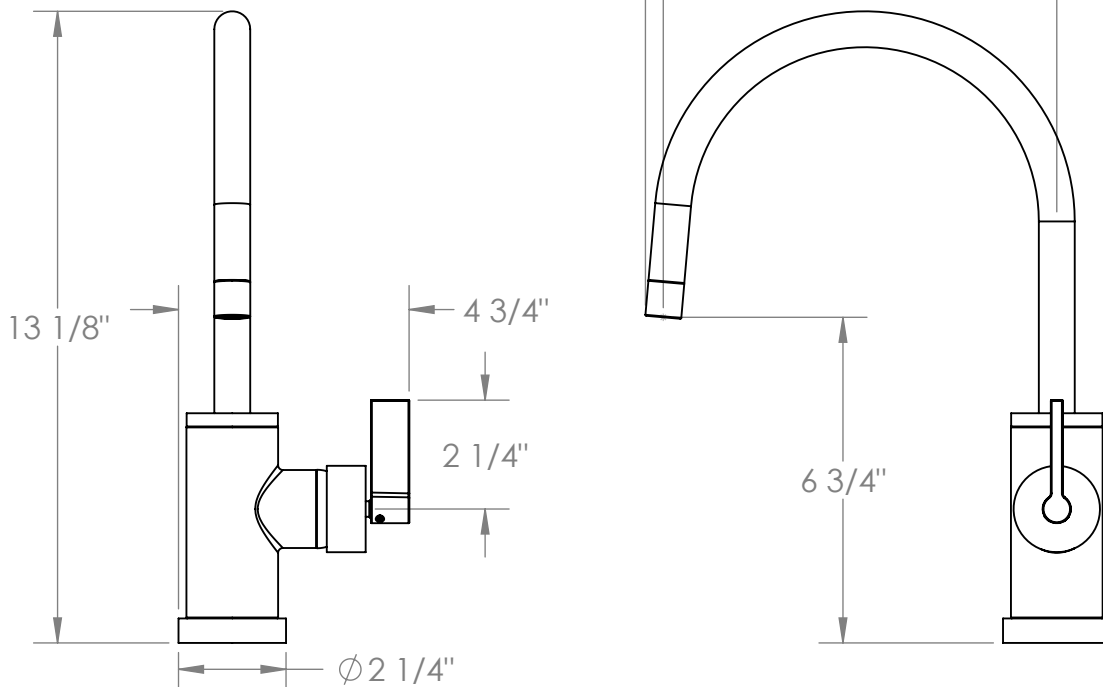

Meets the applicable requirements of ASME A112.18.1-2005/CSA B125.1-05, entitled "Plumbing Supply Fittings"